

UPS PART LIST

	Stck.	Wert/Bezeichnung:	Nomenklatur auf der Platine:	Lieferant:	Hersteller:	Bestellnummer:
1.	18	100 Ohm / 0,5W	RD5,RD8,R6,7,10,11,14,15,18,19,22,23,26,27,30,31,34,35	Digikey	Vishay Dale CMF	CMF100HFCT-ND
2.	2	240(243) Ohm / 0,5W	RD9,RD10,	Digikey	Vishay Dale CMF	CMF243HFCT-ND
3.	2	1K / 0,5W	RD4,RD7	Digikey	Vishay Dale CMF	CMF1.00KHCT-ND
4.	8	4K7(4K75) / 0,5W	R5,12,13,20,24,25,32,33	Digikey	Vishay Dale CMF	CMF4.75KHCT-ND
5.	1	100K / 0,5W	RD11	Digikey	Vishay Dale CMF	CMF100KHCT-ND
6.	3	XXX /0,5W	RLED OUT A ,RLED OUTB, RLED REM.	Digikey	Vishay Dale CMF	
7.	8	1 Ohm / 2W	R39,41,43,44,49,51,53,54	Digikey	Panasonic	P1.0W-2BK-ND
8.	4	3,3 Ohm / 2W	R1,2,3,4	Digikey	Panasonic	P3.3W-2BK-ND
9.	2	47 Ohm / 2W	RD1,2	Digikey	Panasonic	P47W-2BK-ND
10.	12	10K / 2W	R37,38,40,42,45,46,47,48,50,52,55,56	Digikey	Panasonic	P10KW-2BK-ND
11.	2	5 K multiturn trimmer	TD1,2	Digikey	Vishay Sfernice	T93YA-5.0K-ND
12.	2	NTC 5 Ohm	NTCX1,NTC2	Digikey	Epcos	495-2093-ND
13.	7	10nF/63VAC FKP2	CX1,CTR1,2,3,4,CD5,6	Buerklin	Wima	42D754
14.	2	100nF/275VAC (X2)	CX4,5	Digikey	PanasonicECQ UL	P10730-ND
15.	6	(2200uF)220uF/25V	CD5,6,7,8,9,10	Digikey	Panasonic NHG	P5541-ND
16.	8	220uF/50V	C10,11,14,15,18,19,22,23	Digikey	Panasonic NHG	P5572-ND
17.	16	1000uF/50V	C9,12,13,16,17,20,21,24,25,26,27,28,29,30,31,32	Digikey	Panasonic FM	P12393-ND
18.	4	2700uF/25V	CD1,2,3,4	Digikey	Panasonic FM	P12385-ND
19.	2	3900uF/16V	CX2,3	Digikey	Panasonic FM	P12374-ND
20.	8	10000uF/50V	C1,2,3,4,5,6,7,8	Digikey	Panasonic TSHA	P6691-ND
21.	20	Diode 31DQ10	D1,2,3,4,5,6,7,8,9,10,11,12,13,14,15,16,DD1,2,3,4	Digikey	Vishay	31DQ10-ND
22.	6	Diode 1N4148	D17,18,19,20,DD7,8	Digikey	Vishay	1N4148-TAPCT-ND
23.	2	Diode 1N4007	DD5,6	Digikey	Vishay	1N4007-E3/54GICT-ND
24.	2	Diode 1N5404	DX1,2	Digikey	Vishay	1N5404-E3/54GICT-ND
25.	2	Zenerdiode 13V/0,5W	RD3,4	Digikey	NXP	568-5886-1-ND
26.	3	Led diode	LED Ausgang A/B , LED REM.(Betriebsanzeige)			
27.	5	BC639	Q1,3,9,11,QD2	Digikey	ON	BC639-16ZL1GOSCT-ND
28.	5	BC640	Q2,4,10,12,QD4	Digikey	ON	BC640-016GOS-ND
29.	5	2SC4793	Q5,7,13,15,QD1	Digikey	Toshiba	2SC4793FM-ND
30.	5	2SA1837	Q6,8,14,16,QD16	Digikey	Toshiba	2SA1837FM-ND

UPS PART LIST

31.	1	IRF610 (510,630)	QD5	Digikey	Vishay	IRF610PBF-ND
32.	2	LM317	REGD1,2	Digikey	NS	LM317AT-ND
33.	3	VDR 275VAC	VDRX1,2,3	Digikey	Epcos	495-4288-ND
34.	1	25W toroidal transformer	TR1	Reichelt	Talema	RKPT25215
35.	2	Breitbanddrosselspule	LD1,2	Reichelt	FASTRON	06H-85
36.	2	Entstoerdrossel 3A,2mH	LX1,2	Buerklin	Schaffner	76D2084
37.	1	Dil switch 2 polig	SWD1	Reichelt		NT02
38.	1	Dil switch 8 polig	SWD2	Reichelt		NT08
39.	6	Miniatur Relais 12VDC	RY1,2,3,4,RYD1,2	Reichelt	--	FRT5 DC12V
40.	24	Schraubklemme 2 pol. anrei.	CON1,2,3,4,5,6,7,8,9,10,11	Conrad	PTR AKZ 350	731986 - 62
41.	6	Steckverbinder 2 pol. komp.	SW OUT A,B , LED OUT A,B , PS, LEDREM	Reichelt		PS25/2G BR
42.	10	Kuehlkoerper	SK 104/25,4 STS	Reichelt	Fischer	V PR32/25,4
43.	2	Sicherungshalter PLOGD	Fuse1,2	Reichelt	Schurter	PL OGD
44.	2	Kappe fuer Sicherungshalter	Fuse1,2	Reichelt	Schurter	PL OGD Kappe
45.	1	Halter f. Minisicherung	F3	Reichelt	ELU	PL 166600
46.	1	Minisicherung 315mA	F3	Reichelt	ESKA	Mini traeege 0,315
47.	12	Loetstuetzpunkt		Buerklin		12H6142
48.	29	Abstandshalter	10 – 15mm M3			
49.	29	Schraube	M3 x 6mm			
50.	1	Schraube fuer Talema Trafo	M4 x 10mm			
51.	2	Schalter fuer Ausgang A-B	nach eigener Wahl			

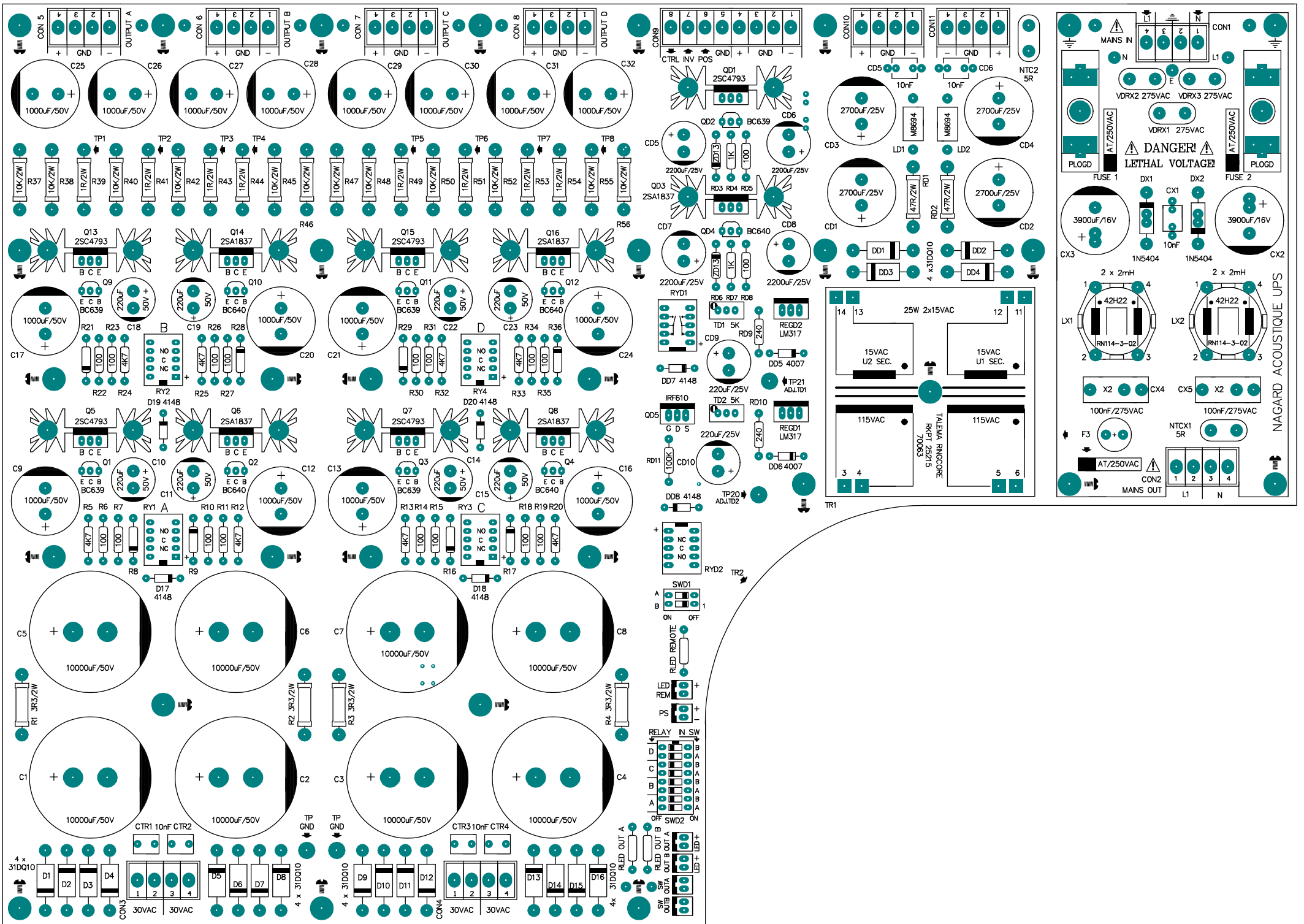

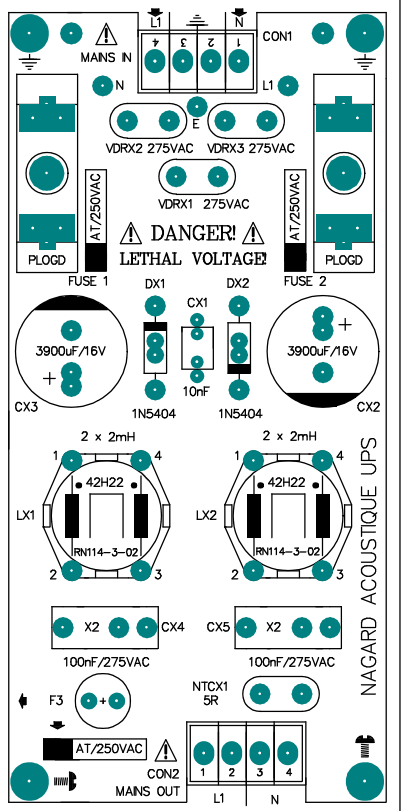
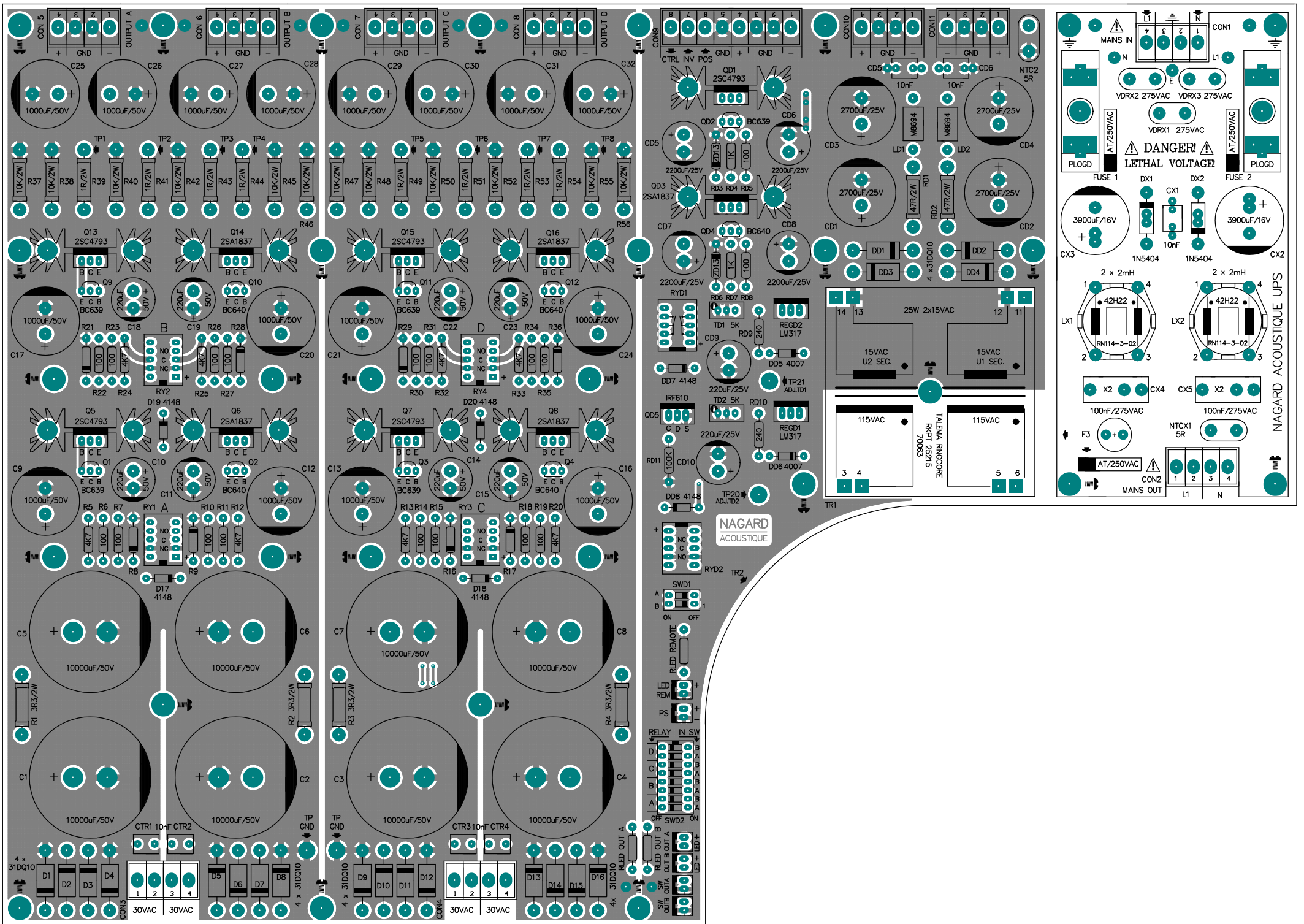

NAGARD ACOUSTIQUE UPS

NAGARD ACOUSTIQUE

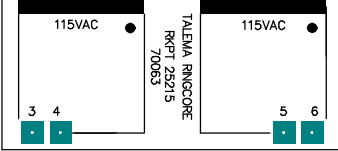

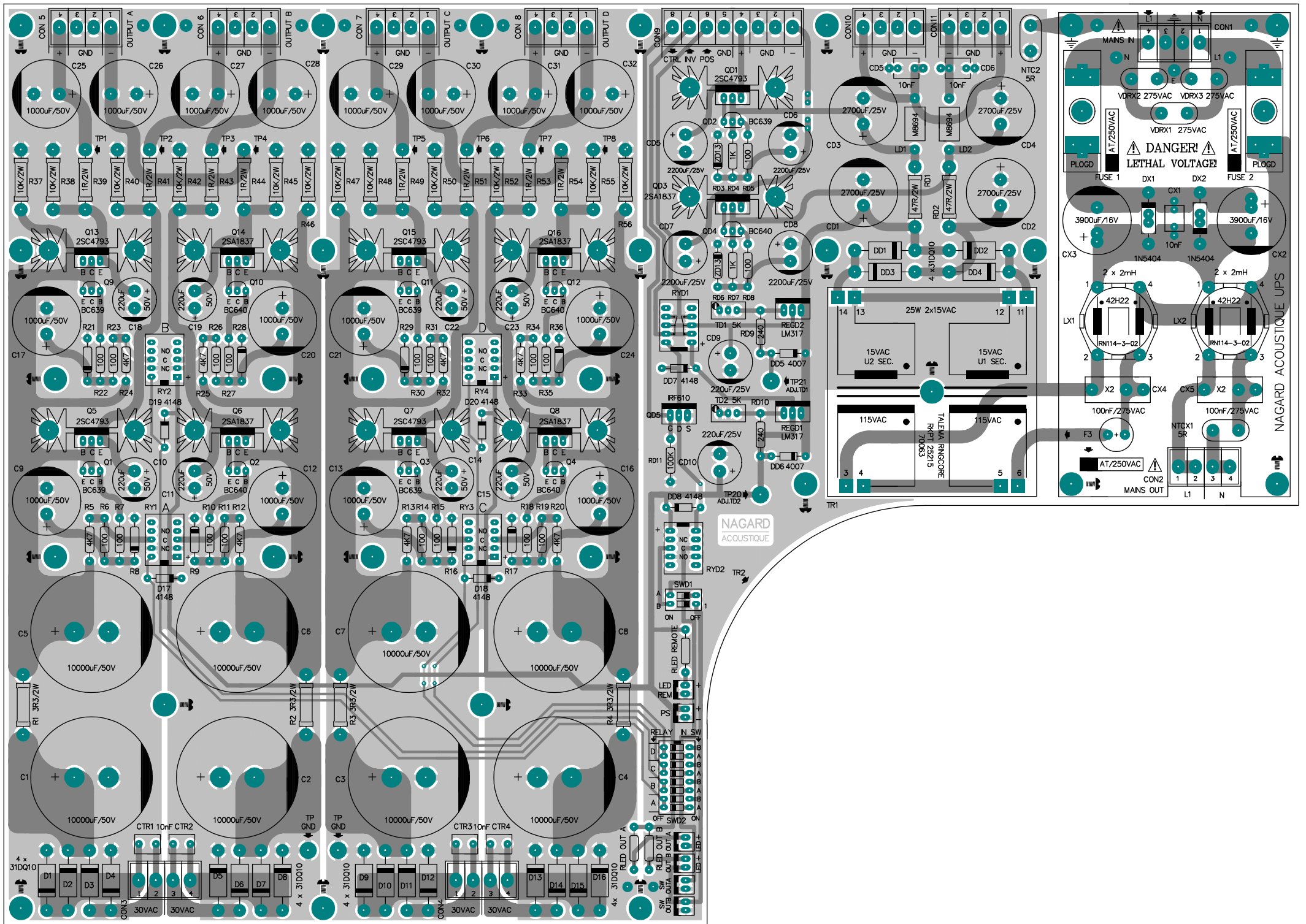

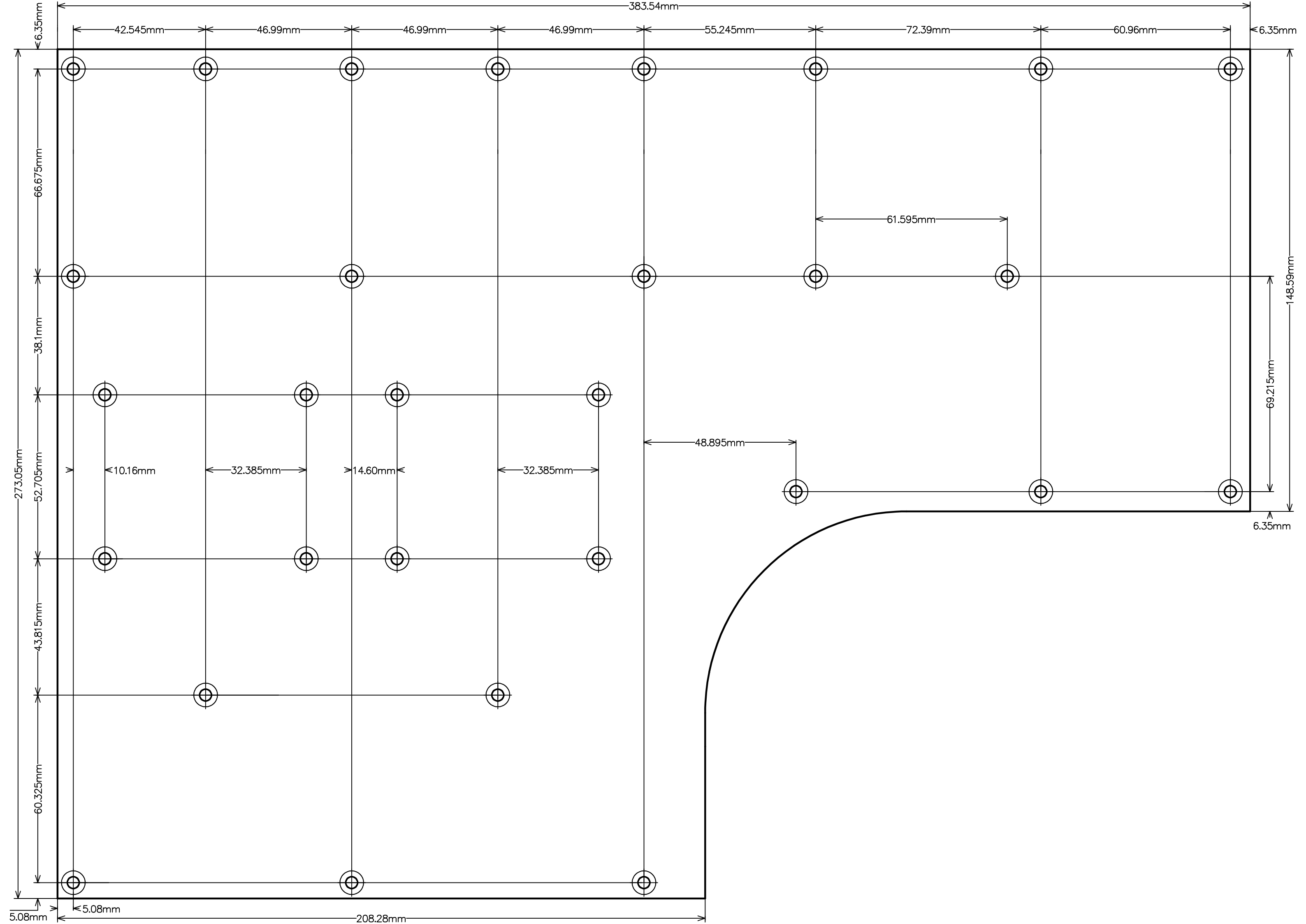

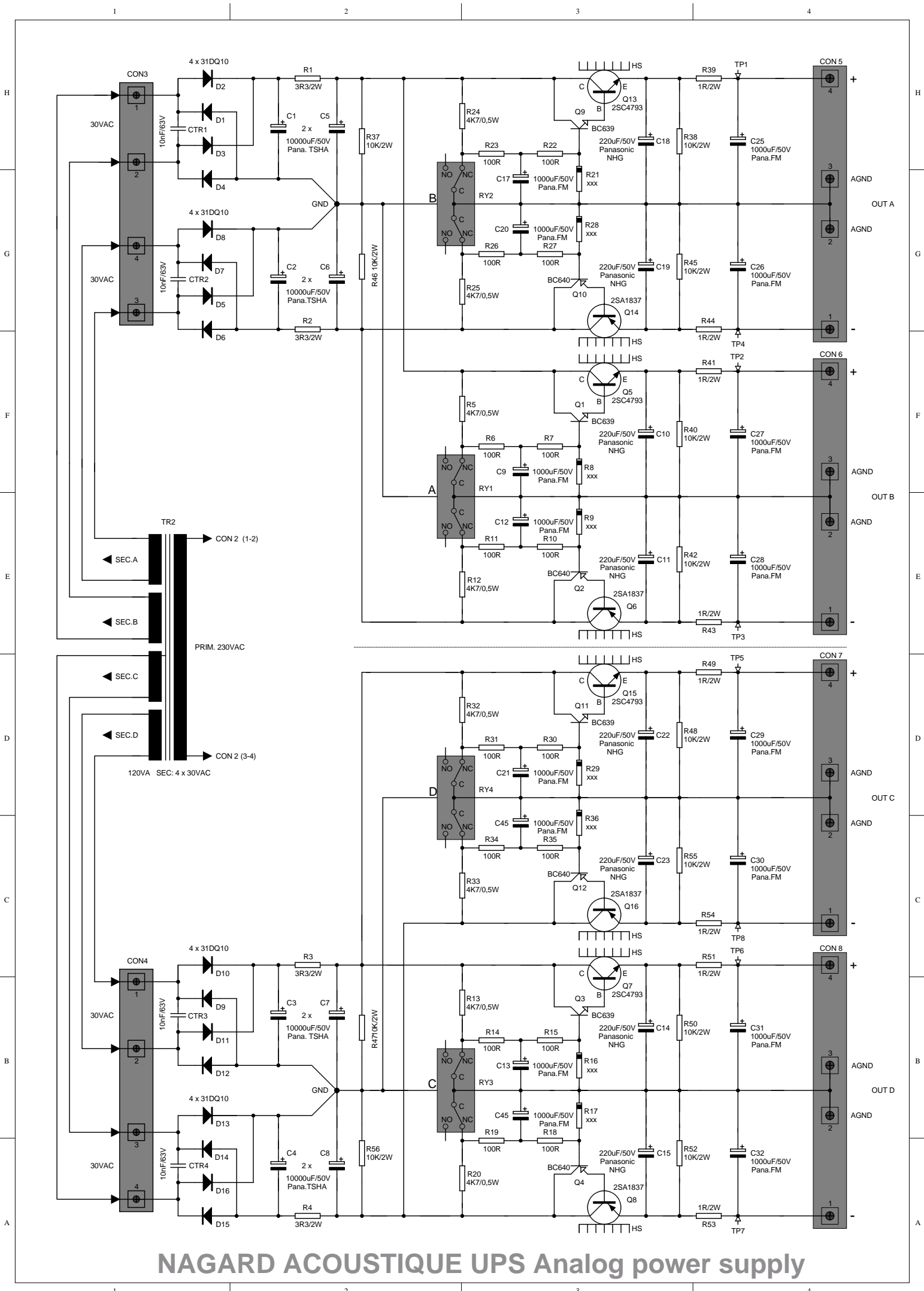

NAGARD ACOUSTIQUE UPS Analog power supply

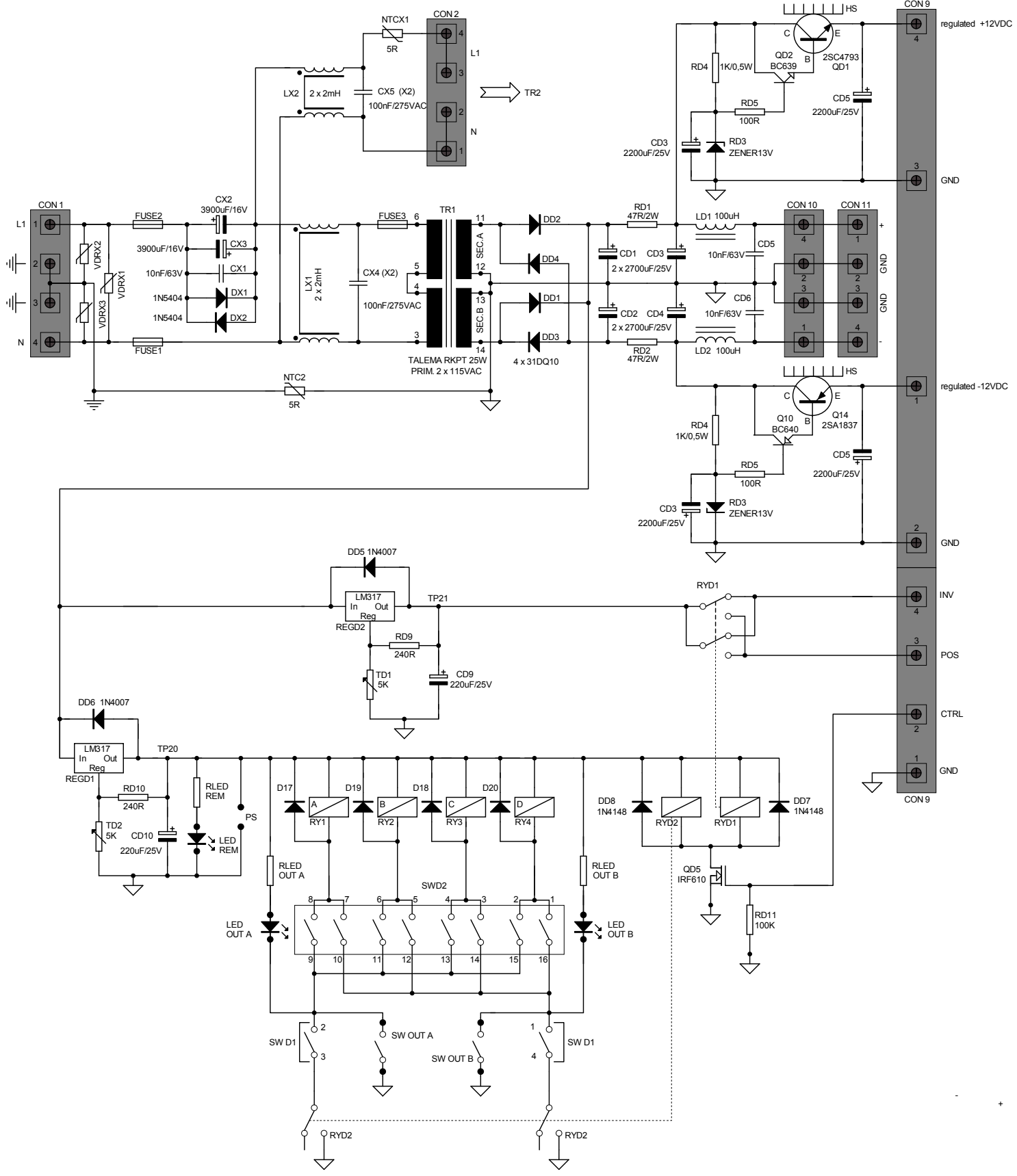

L1
N

F

E

D

C

B

A

CON 9
4 regulated +12VDC
3 GND

CON 10
4 regulated -12VDC
3 GND

CON 11
4 INV
3 POS
2 CTRL
1 GND

CON 9
2 GND

C

B

A